

# Surface Bolts

The 0445 Knob Slide Surface Mounted Door Bolt comes with a spring loaded stop button, is offered in several lengths and with a Cranked Shoot option.



▲ 0445 shown with staple option (ST)



shoot size 13 x 13  
length of throw 25  
projection 47

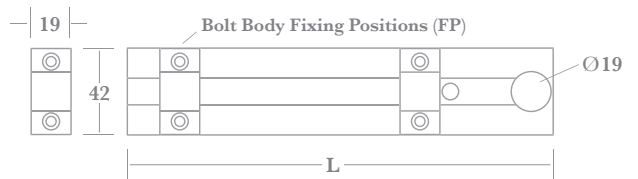

	A	B	C	D	E	F	custom lengths upon request (203mm minimum)
L (length)	203	305	381	457	610	914	
FP (no.)	4	4	4	6	6	6	

(\*) cranked shoot available on size C and above

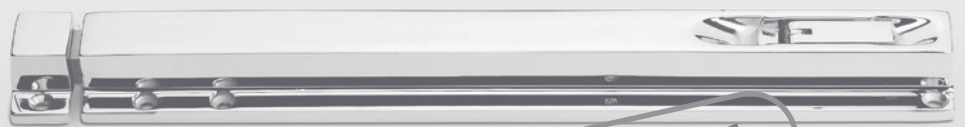

**Discontinued**  
May 2021

▲ 0454 shown with staple option (ST)

shoot size 16 x 13  
length of throw 16  
projection 22

	A	B
L (length)	229	305

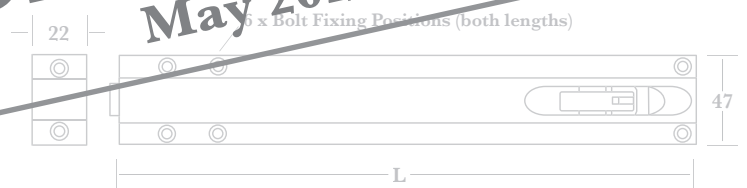

## Fixings

Bolt Bodies & Staples (ST) supplied with finish matched no.8 x 25mm wood screws.

FP, AP & UP supplied with finish matched no.6 x 19mm wood screws.

## How to Order

- 1) select BOLT (e.g. 0445)
- 2) add FINISH (e.g. 0445PC)
- 3) add SIZE (e.g. 0445PC/B)
- 4) choose FRAME PLATE/STAPLE if known (e.g. 0445PC/B/UP).

If frame plate/staple is not specified (e.g. 0445PC/B) both an ST and FP will be supplied.

0445 - CRANKED SHOOT available on C size and above (e.g. 0445PC/C/CK or 0445PC/C/UP/CK).

**Finishes** - See our price list or website for finish availability.

▲ <b>FP</b> Flat Strike Plate	▲ <b>AP</b> Angle Strike Plate	▲ <b>UP</b> Universal Strike Plate	▲ <b>CK</b> cranked version
see pages DB4:020 & 021 to order Strikes & Staples separately if required			

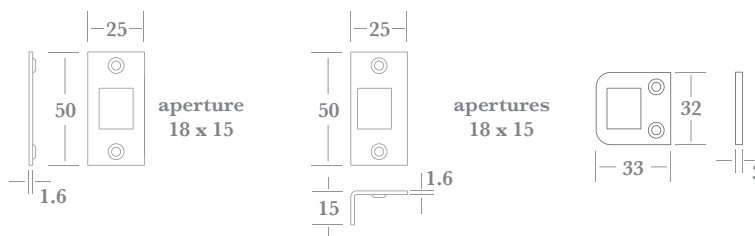





# Surface Bolts

Two Surface Mounted Door Bolts incorporating a concealed spring loaded mechanism to hold the bolt shoot in the thrown & retracted positions. Available in various lengths offered with a locking option featuring a finish matched non-removable Locking Cap, a Cranked Shoot version, and the option of a fully retractable Extended Throw.



▲ **6481** shown with staple option (ST)

 ▲ <b>LK</b> (size A & above) lockable version with nickel plated key	 type 2 supplied ▲ <b>FP</b> Flat Strike Plate see pages DB4:020 & 021 to order Strikes & Staples separately if required	 type 2 supplied ▲ <b>AP</b> Angle Strike Plate	 type 2 supplied ▲ <b>UP</b> Universal Strike Plate	 ▲ <b>CK</b> cranked version (*)
-----------------------------------------------------------------------------------------------------------------------------------------------------------	--------------------------------------------------------------------------------------------------------------------------------------------------------------------------------------------------------------------	------------------------------------------------------------------------------------------------------------------------------------------	----------------------------------------------------------------------------------------------------------------------------------------------	------------------------------------------------------------------------------------------------------------------------



shoot size 14 x 8  
length of throw 25  
(extended throw available - see notes)  
projection 39

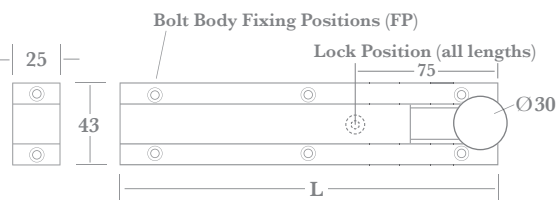

	AA	A	B	C	D	E	F	custom lengths upon request (100mm minimum)
L (length)	100	150	200	250	300	450	600	
FP (no.)	4	4	6	6	6	8	8	

(\*) cranked shoot available on size A and above

## Fixings

6481 Bolt Body & Staple (ST) supplied with finish matched no.8 x 25mm wood screws.

6473 Bolt Body & Staple supplied with finish matched no.6 x 25mm wood screws.

FP's, AP's & UP's supplied with finish matched no.6 x 19mm wood screws.

## How to Order

- 1) select BOLT (e.g. **6481**)
- 2) choose LOCKING OPTION if required (e.g. 6481**LK**)
- 3) add FINISH (e.g. 6481**PB** or 6481**LK/PB**)
- 3) add SIZE (e.g. 6481**PB/B** or 6481**LK/PB/B**)
- 4) choose FRAME PLATE/STAPLE if known (e.g. 6481**PB/B/FP** or 6481**LK/PB/B/FP**).

If frame plate/staple is not specified (e.g. 6481**LK/PB/B**) both an ST and FP will be supplied.





CRANKED SHOOT available on 150mm and above (e.g. 6481**PB/A/ST/CK**).

EXTENDED THROW available on bolts 200mm+ please specify total throw required (e.g. 6481**PB/B/ST/ET40**).

**Finishes** - See our price list or website for finish availability.



▲ **6473** shown with staple option (ST)

 ▲ <b>LK</b> (size B & above) lockable version with nickel plated key	 type 3 supplied ▲ <b>FP</b> Flat Strike Plate see pages DB4:020 & 021 to order Strikes & Staples separately if required	 type 3 supplied ▲ <b>AP</b> Angle Strike Plate	 type 3 supplied ▲ <b>UP</b> Universal Strike Plate	 ▲ <b>CK</b> cranked version (*)
-------------------------------------------------------------------------------------------------------------------------------------------------------------	----------------------------------------------------------------------------------------------------------------------------------------------------------------------------------------------------------------------	--------------------------------------------------------------------------------------------------------------------------------------------	------------------------------------------------------------------------------------------------------------------------------------------------	--------------------------------------------------------------------------------------------------------------------------

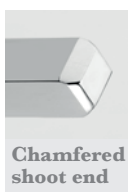

shoot size 10 x 10  
length of throw 20  
(extended throw available - see notes)  
projection 28

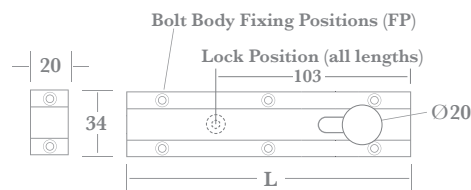

	A	B	C	custom lengths upon request (100mm minimum)
L (length)	100	150	200	
FP (no.)	4	6	6	

(\*) cranked shoot available on size B and above

# Skeleton Bolts

Two Surface Mounted Skeleton Door Bolts incorporating a concealed spring loaded mechanism to hold the bolt shoot in the thrown & retracted positions, both offered in several lengths, and both available with the option of a Cranked Shoot.

The 6507 complements the 0807 type Cremona Bolt and the 6536 complements the 0836 & 0846 types (see section DB3).

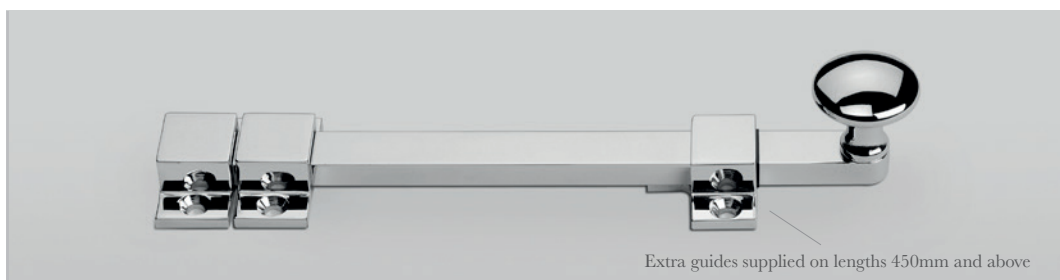
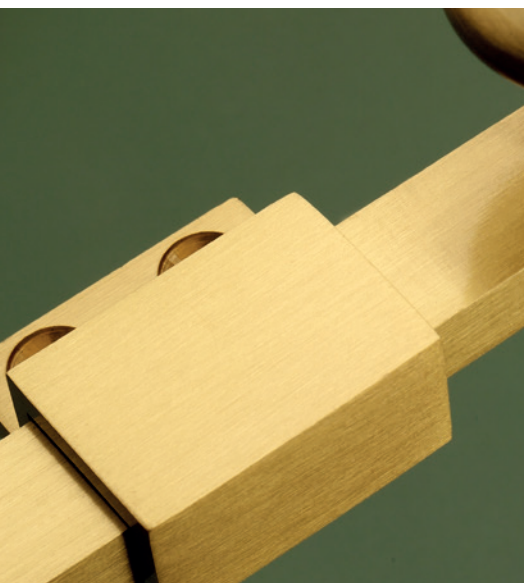

Extra guides supplied on lengths 450mm and above

▲ 6507 shown with staple option (ST)

shoot size 14 x 8  
length of throw 20  
projection 39



Chamfered shoot end

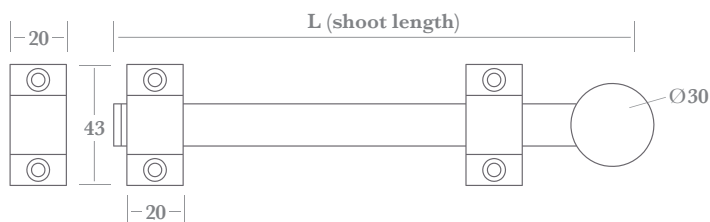

	A	B	C	D	E	F	G	custom lengths upon request (120mm minimum)
L	120	150	200	250	300	450	600	

(\*) cranked shoot available on size B and above



Extra guides supplied on lengths 450mm and above

▲ 6536 LH shown with staple option (ST)

shoot size 14 x 8  
length of throw 20  
projection 39



Chamfered shoot end

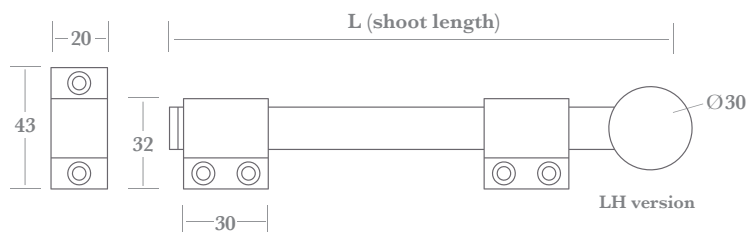

	A	B	C	D	E	F	G	custom lengths upon request (120mm minimum)
L	120	150	200	250	300	450	600	

(\*) cranked shoot available on size B and above

## Fixings

Bolt Bodies & Staples (ST) supplied with finish matched no.8 x 25mm wood screws.  
FP, AP & UP supplied with finish matched no.6 x 19mm wood screws.

## How to Order

- 1) select BOLT (e.g. 6507)
- 2) add FINISH (e.g. 6507PC)
- 3) add SIZE (e.g. 6507PC/B)
- 4) choose FRAME PLATE/STAPLE if known (e.g. 6507PC/B/UP).

If frame plate/staple is not specified (e.g. 6507PC/B) an ST, FP and AP will be supplied.

6536 only - add HANDING (e.g. 6536PC/B/UP/LH).

CRANKED SHOOT available on B size and above (e.g. 6507PC/B/CK or 6536PC/C/UP/LH/CK).

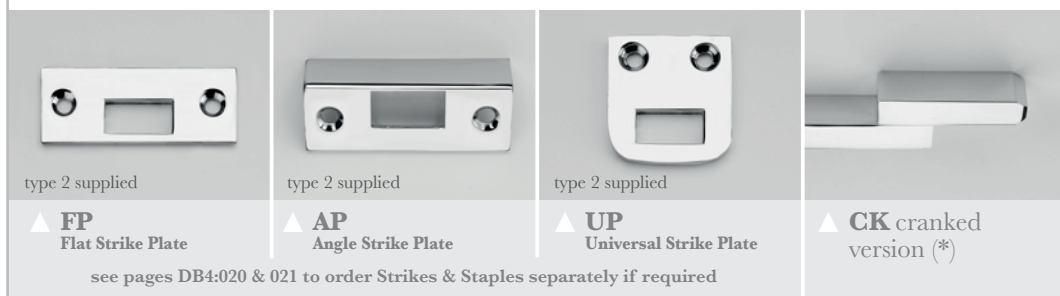

type 2 supplied

type 2 supplied

type 2 supplied

▲ FP Flat Strike Plate

▲ AP Angle Strike Plate

▲ UP Universal Strike Plate

▲ CK cranked version (\*)

see pages DB4:020 & 021 to order Strikes & Staples separately if required

**Finishes** - See our price list or website for finish availability.

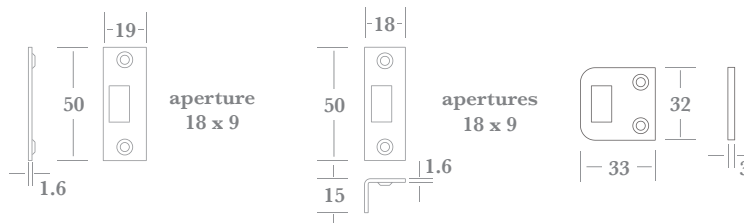



# Skeleton Bolts

Three Surface Mounted Skeleton Door Bolts incorporating a concealed spring loaded mechanism to hold the bolt shoot in the thrown & retracted positions, both offered in several lengths, and both available with the option of a Cranked Shoot.

The 6510 and 6511 complement the 0810 type Cremone Bolt and the 6522 complements the 0822 type (see section DB3).



## Fixings

Bolt Bodies & Staples (ST) supplied with finish matched no.6 x 25mm wood screws.  
FP, AP & UP supplied with finish matched no.6 x 19mm wood screws.

## How to Order

- 1) select BOLT (e.g. **6510**)
- 2) add FINISH (e.g. 6510**PC**)
- 3) add SIZE (e.g. 6510**PC/B**)
- 4) choose FRAME PLATE/STAPLE if known (e.g. 6510**PC/B/UP**).

If frame plate/staple is not specified (e.g. 6510**PC/B**) an ST, FP, and AP will be supplied.

CRANKED SHOOT available on B size and above (e.g. 6510**PC/B/CK** or 6510**PC/C/UP/CK**).

**Finishes** - See our price list or website for finish availability.

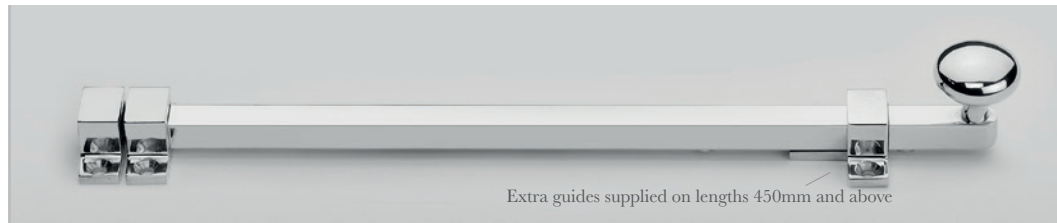

▲ **6510** shown with staple option (ST)



▲ **6511** shown with staple option (ST)



▲ **6522** shown with staple option (ST)

shoot size 10 x 10  
length of throw 20  
6510/6522 projection 36  
6511 projection 27

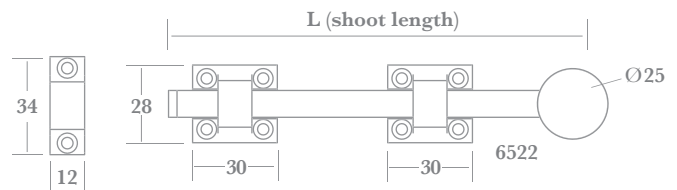
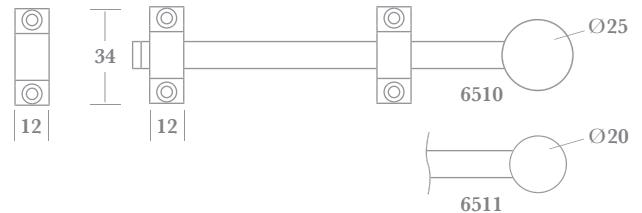

	A	B	C	D	E	F	G	custom lengths upon request (120mm minimum)
L	120	150	200	250	300	450	600	

(\*) cranked shoot available on size B and above

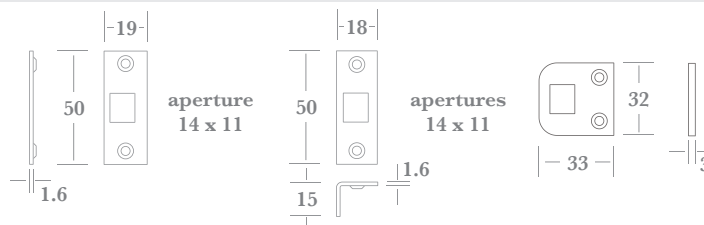
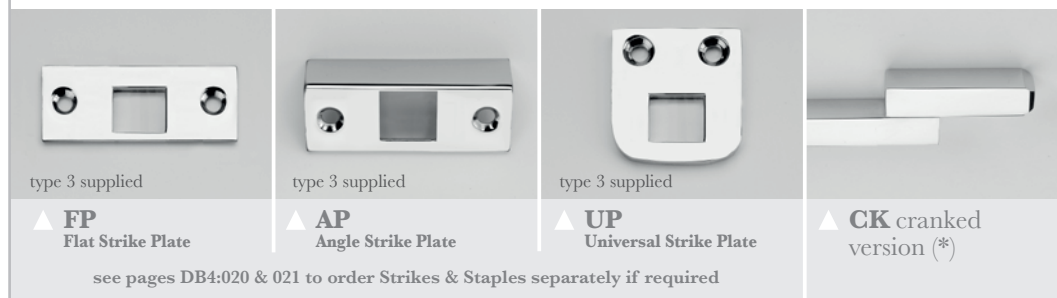

# Skeleton Bolts

Two Surface Mounted Skeleton Door Bolts offered with different knob designs incorporating a concealed spring loaded mechanism to hold the bolt shoot in the thrown & retracted positions. Both are available in several lengths, and with the option of a Cranked Shoot.

Both complement the 0801 type Cremone Bolt (see section DB3).

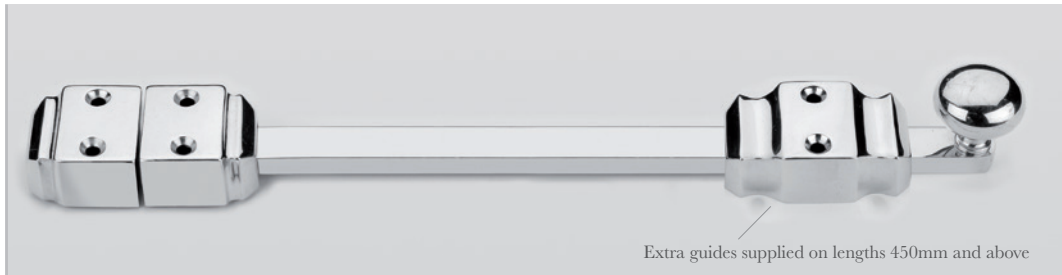

Extra guides supplied on lengths 450mm and above

▲ **6501** shown with staple option (ST)

shoot size 13 x 6  
length of throw 18  
projection 32



Chamfered shoot end

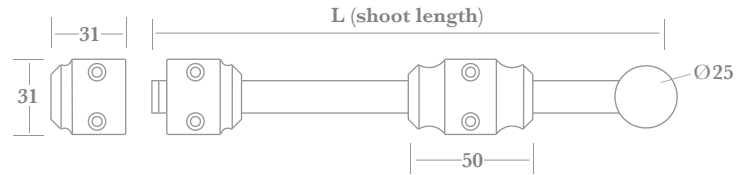

	A	B	C	D	E	F	G	custom lengths upon request (120mm minimum)
L	120	150	200	250	300	450	600	

(\*) cranked shoot available on size C and above



Extra guides supplied on lengths 450mm and above

▲ **6503** shown with staple option (ST)

shoot size 13 x 6  
length of throw 18  
projection 34



Chamfered shoot end

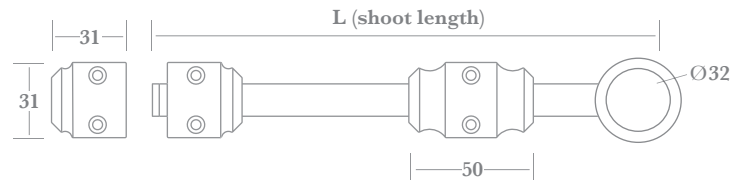

	A	B	C	D	E	F	G	custom lengths upon request (120mm minimum)
L	120	150	200	250	300	450	600	

(\*) cranked shoot available on size C and above

## Fixings

Bolt Bodies & Staples (ST) supplied with finish matched no.6 x 32mm wood screws.  
FP, AP & UP supplied with finish matched no.6 x 19mm wood screws.

## How to Order

- 1) select BOLT (e.g. 6501)
- 2) add FINISH (e.g. 6501PC)
- 3) add SIZE (e.g. 6501PC/B)
- 4) choose FRAME PLATE/STAPLE if known (e.g. 6501PC/B/UP).

If frame plate/staple is not specified (e.g. 6501PC/B) an ST, FP, and AP will be supplied.

CRANKED SHOOT available on C size and above (e.g. 6501PC/C/CK or 6501PC/C/UP/CK).

**Finishes** - See our price list or website for finish availability.

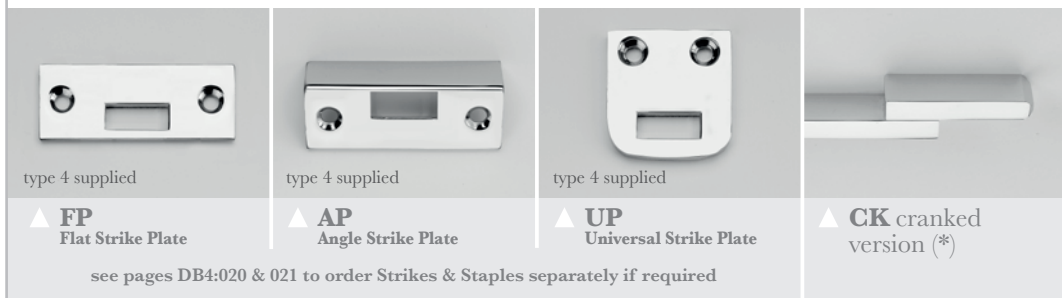

type 4 supplied

type 4 supplied

type 4 supplied

▲ **FP**  
Flat Strike Plate

▲ **AP**  
Angle Strike Plate

▲ **UP**  
Universal Strike Plate

▲ **CK** cranked version (\*)

see pages DB4:020 & 021 to order Strikes & Staples separately if required

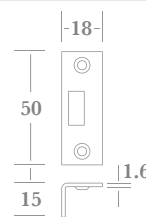
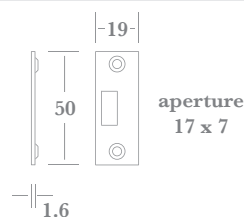

apertures  
17 x 7



# Chain Bolt & Foot Bolt

A spring loaded Chain Bolt supplied with a Hold Open Peg to secure the Chain Ring in the retracted position, along with a matching Foot Bolt.

Both are available in two lengths as standard.

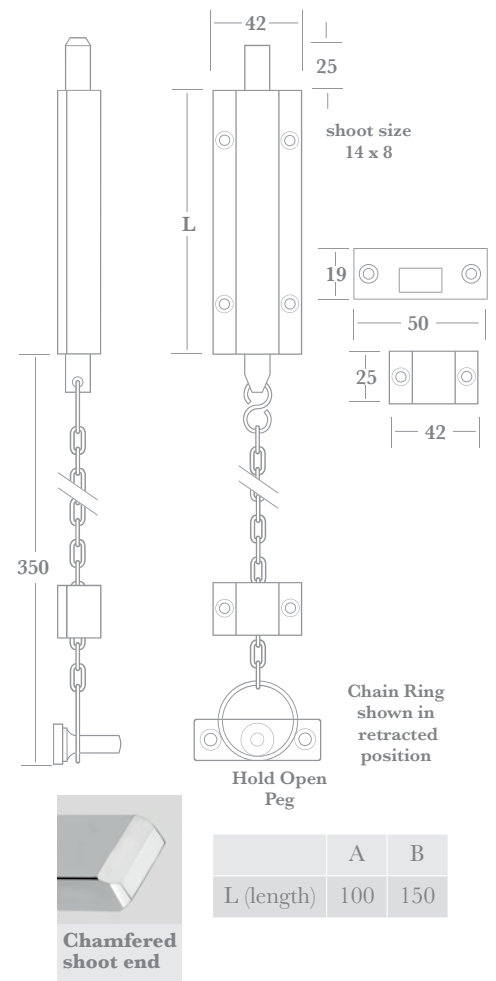

6494 (available with longer chains upon request)

## Fixings

Supplied with finish matched no.8 x 25mm wood screws (except Flat Strike Plates no.6 x 19mm & Easy-Clean Floor Sockets no.6 x 38mm).

## How to Order

- 1) select BOLT (e.g. 6494)
- 2) add FINISH (e.g. 6494PC)
- 3) add SIZE (e.g. 6494PC/B).

**Finishes** - See our price list or website for finish availability.

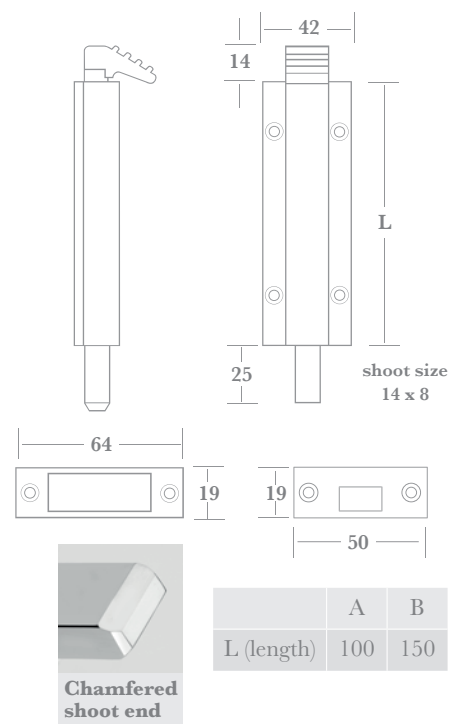

▲ 6492

# Loop Handle Bolt

A Loop Handle Bolt that can be installed either at the top of a tall door, or at the bottom of any door, where ease of use is important. The generously designed Loop Handle provides for a good grip and is ideal for anyone who finds a regular knob type bolt difficult to operate. This Bolt incorporates a concealed spring loaded mechanism to hold the bolt shoot in the thrown & retracted positions.

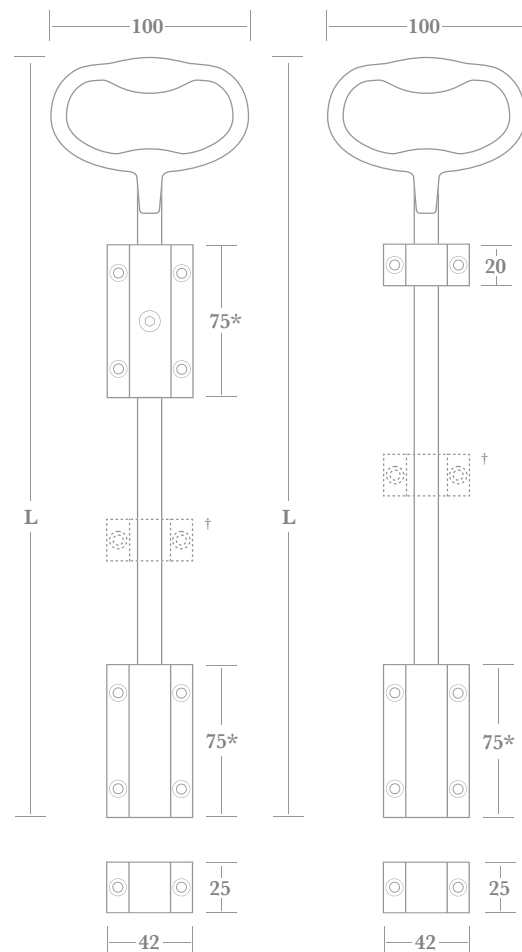

lockable version (LK)      non-lockable version

maximum projection 42 (including loop handle)  
shoot size 14 x 8  
length of throw 25 (extended throw available, B size and above)



Chamfered shoot end

† Extra Guides will be supplied for lengths over 600mm.  
\* Please note guide lengths will increase when ordering extended throw versions.

## Fixings

Bolt Body & Staple (ST) supplied with finish matched no.8 x 25mm wood screws. FP's, AP's & UP's supplied with finish matched no.6 x 19mm wood screws.

## How to Order





- 1) select BOLT (e.g. 6487)
- 2) choose LOCKING OPTION if required (e.g. 6487LK)
- 3) add FINISH (e.g. 6487PB or 6487LK/PB)
- 3) add SIZE (e.g. 6487PB/B or 6487LK/PB/B)
- 4) choose FRAME PLATE/STAPLE if known (e.g. 6487PB/B/UP or 6487LK/PB/B/UP).

If frame plate/staple is not specified, (e.g. 6487LK/PB/B), both an ST and FP will be supplied.

CRANKED SHOOT available if required (e.g. 6487PB/B/ST/CK). EXTENDED THROW available (B size and above), please specify total throw required (e.g. 6487PB/B/ST/ET40).

**Finishes** - See our price list or website for finish availability.

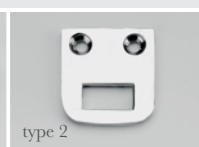
▲ 6487 shown with staple option (ST)

				
▲ LK lockable version (nickel plated key supplied)	▲ FP Flat Strike Plate	▲ AP Angle Strike Plate	▲ UP Universal Strike Plate	▲ CK cranked version
see pages DB4:020 & 021 for Strike Plate & Staple dimensions (and to order separately if required)				

	A	B	C	D	custom lengths upon request (300mm minimum)
L (length)	300	400	500	600	



# Privacy Bolts

The 8052 & 8053 Privacy Bolts are designed for use on traditional closet doors and feature an external emergency coin release. They are non-handed and supplied with a reversible disc offering a choice of either vacant/engaged or red/green indication.

The 0448 is a small yet versatile Bolt which is suitable for door, cabinet, or window applications.

Both Bolts are available with alternative Knob designs and extended shoots. Please contact us to discuss possibilities.



box keeper

universal strike plate

reversible disc  
vacant / engaged  
or red / green

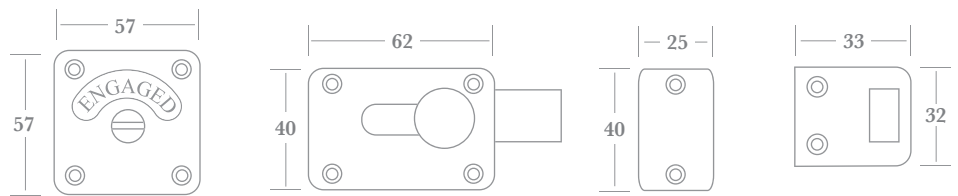

shoot size 13 x 6, length of throw 22, projection 24

- ▲ 8052 Privacy Bolt Set supplied with Box Keeper
- 8053 Privacy Bolt Set supplied with Universal Strike Plate

## Fixings

0448 supplied with finish matched no.6 x 19mm wood screws.  
8052 supplied with finish matched no.6 x 25mm wood screws.  
8053 supplied with finish matched no.6 x 19mm & no.6 x 25mm wood screws.

## How to Order

- 1) select BOLT (e.g. 0448)
- 2) add FINISH (e.g. 0448PC).

Angle Strike Plate available to order separately - use code 0448ASP (e.g. 0448ASP/PC)

**Finishes** - See our price list or website for finish availability.

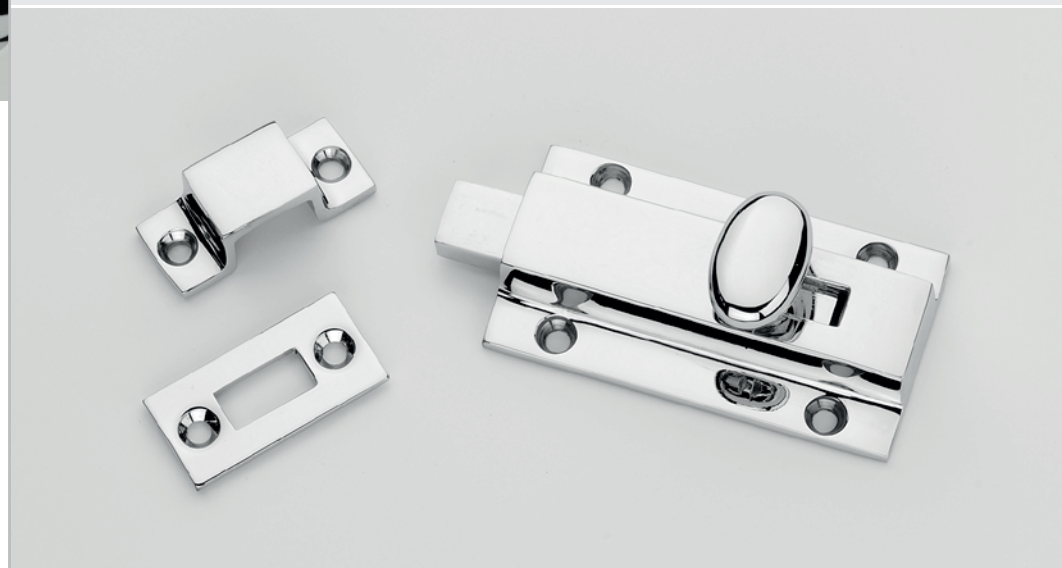

- ▲ 0448 supplied with both Staple & FSP (Angle Strike Plate available to order separately)

shoot size 13 x 6  
length of throw 12  
projection 28

